



STANDARD PRODUCT

Date: 09/10/2008

Prepared for: Production

DC Gearmotor

Model Number: MMP PDSF80-12V GS-060

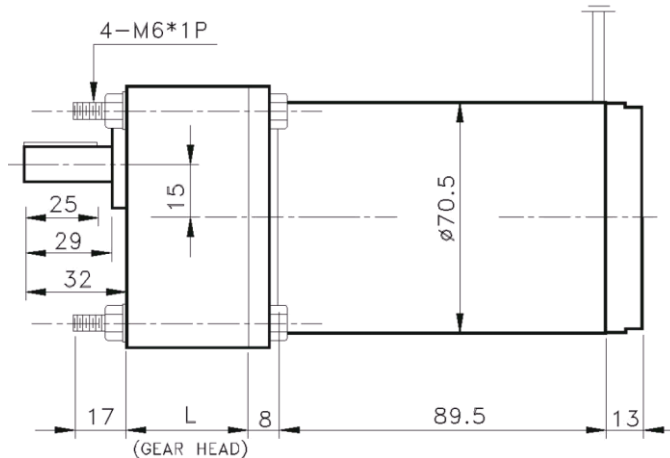
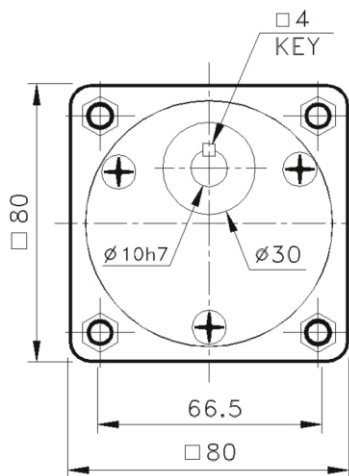

DC MOTOR PERFORMANCE PARAMETERS	Value	Units	Tolerance
RATED VOLTAGE D.C.	12	VOLTS	----
RATED CONTINUOUS CURRENT	5.2	AMPERE	----
RATED CONTINUOUS TORQUE	28	OZ - IN	----
RATED SPEED	2600	RPM	+/- 15%
RATED CONTINUOUS POWER OUT	54	WATTS	+/- 15%
NO LOAD SPEED	3000	RPM	MAX
NO LOAD CURRENT	1.3	AMPS	MAX
BACK EMF CONSTANT (Ke)	4.0	V/KRPM	+/- 10%
TORQUE CONSTANT (Kt)	5.4	OZ - IN / A	+/- 10%
DC ARMATURE RESISTANCE AT 1.5 AMPS	3.6	OHMS	+/- 15%
ARMATURE TEMP	155	DEGR. C	MAX
PEAK TORQUE	TBD	OZ - IN	----
GEARMOTOR OUTPUT PARAMETERS:			
GEARBOX RATIO	60 : 1		
GEARBOX RATED CONTINUOUS TORQUE	69	LB - IN	MAX
GEARBOX RATED PEAK TORQUE	70++	LB. - IN	MAX
GEARBOX SHAFT OUTPUT SPEED *	43	RPM	----
GEARBOX EFFICIENCY	66	%	
TOTAL GEARMOTOR WEIGHT	~64	OUNCES	MAX
"L" Dimension—Gearbox Length	1.9	INCHES	MAX.

MMP PDSF80-12V 60 : 1 Note: Overall Gearmotor Length = 5.4 Inches

++ All Peak Torque Values are dependent upon duty. Kindly consult our Sales Offices for further details

MIDWEST MOTION PRODUCTS

Design, Manufacturing & Distribution – Motion Control Equipment

10761 Ahern Avenue S. E. Watertown, MN. 55388

Phone: 952-955-2626 Fax: 480-247-4096

www.midwestmotion.com

email: randy@midwestmotion.com